

UNITED STATES
SECURITIES AND EXCHANGE COMMISSION
Washington, D.C. 20549

FORM 8-K

CURRENT REPORT
Pursuant to Section 13 or 15(d) of the
Securities Exchange Act of 1934

Date of Report (Date of earliest event reported): November 20, 2024

QUANTUM-SI INCORPORATED

(Exact name of registrant as specified in its charter)

Delaware
(State or other jurisdiction of incorporation)

001-39486
(Commission File Number)

85-1388175
(IRS Employer Identification No.)

29 Business Park Drive
Branford, Connecticut
(Address of principal executive offices)

06405
(Zip Code)

Registrant's telephone number, including area code: (866) 688-7374

N/A
(Former name or former address, if changed since last report)

Check the appropriate box below if the Form 8-K filing is intended to simultaneously satisfy the filing obligation of the registrant under any of the following provisions:

- Written communications pursuant to Rule 425 under the Securities Act (17 CFR 230.425)
 Soliciting material pursuant to Rule 14a-12 under the Exchange Act (17 CFR 240.14a-12)
 Pre-commencement communications pursuant to Rule 14d-2(b) under the Exchange Act (17 CFR 240.14d-2(b))
 Pre-commencement communications pursuant to Rule 13e-4(c) under the Exchange Act (17 CFR 240.13e-4(c))

Securities registered pursuant to Section 12(b) of the Act:

Title of each class	Trading Symbol(s)	Name of each exchange on which registered
Class A common stock, par value \$0.0001 per share	QSI	The Nasdaq Stock Market LLC
Redeemable warrants, each whole warrant exercisable for one share of Class A common stock, each at an exercise price of \$11.50 per share	QSIW	The Nasdaq Stock Market LLC

Indicate by check mark whether the registrant is an emerging growth company as defined in Rule 405 of the Securities Act of 1933 (§230.405 of this chapter) or Rule 12b-2 of the Securities Exchange Act of 1934 (§240.12b-2 of this chapter).
Emerging growth company

If an emerging growth company, indicate by check mark if the registrant has elected not to use the extended transition period for complying with any new or revised financial accounting standards provided pursuant to Section 13(a) of the Exchange Act.

Item 7.01 Regulation FD Disclosure.

From time to time, Quantum-Si Incorporated (the "Company") presents and/or distributes slides and presentations to the investment community to provide updates and summaries of its business. On November 20, 2024, the Company gave a presentation at its Investor & Analyst Day. The presentation slides and a replay of the webcast are available on the "Investors" section of the Company's website at <https://ir.quantum-si.com>. This presentation is also furnished as Exhibit 99.1 to this Current Report on Form 8-K.

The information in this Item 7.01, including Exhibit 99.1, is being furnished and shall not be deemed "filed" for purposes of Section 18 of the Securities Exchange Act of 1934, as amended (the "Exchange Act"), or otherwise subject to the liabilities of that Section, nor shall it be deemed incorporated by reference into any registration statement or other filing under the Securities Act of 1933, as amended, or the Exchange Act, except as shall be expressly set forth by specific reference in such filing. The furnishing of the information in this Item 7.01 and Exhibit 99.1 is not intended to, and does not, constitute a determination or admission by the Company that the information in this report is material or complete, or that investors should consider this information before making an investment decision with respect to any security of the Company or any of its affiliates.

Item 9.01 Financial Statements and Exhibits.

(d) Exhibits.

Exhibit No.	Description
99.1	Corporate Presentation of Quantum-Si Incorporated dated November 20, 2024.
104	Cover Page Interactive Data File (embedded within the Inline XBRL document).

SIGNATURES

Pursuant to the requirements of the Securities Exchange Act of 1934, the registrant has duly caused this report to be signed on its behalf by the undersigned hereunto duly authorized.

QUANTUM-SI INCORPORATED

By: /s/ Christian LaPointe, Ph.D.
Name: Christian LaPointe, Ph.D.
Title: General Counsel

Date: November 20, 2024

QUANTUM SI

Investor & Analyst Day
November 20, 2024



Disclaimer and Other Information

Forward Looking Statements

This presentation includes "forward-looking statements" within the meaning of the "safe harbor" provisions of the United States Private Securities Litigation Reform Act of 1995. The actual results of the Company may differ from its expectations, estimates, and projections and, consequently, you should not rely on these forward-looking statements as predictions of future events. Words such as "expect," "estimate," "project," "budget," "forecast," "anticipate," "intend," "plan," "may," "will," "could," "should," "believes," "predicts," "potential," "continue," and similar expressions (or the negative versions of such words or expressions) are intended to identify such forward-looking statements. These forward-looking statements include, without limitation, the Company's expectations with respect to future performance and development and commercialization of products and services, its anticipated cash runway and its financial guidance for the full year 2024. These forward-looking statements involve significant risks and uncertainties that could cause the actual results to differ materially from those discussed in the forward-looking statements. Most of these factors are outside the Company's control and are difficult to predict. Factors that may cause such differences include, but are not limited to: the inability to maintain the listing of the Company's Class A common stock on The Nasdaq Stock Market; the ability of the Company to grow and manage growth profitably and retain its key employees; the Company's ongoing leadership transitions; changes in applicable laws or regulations; the ability of the Company to raise financing in the future; the success, cost and timing of the Company's product development and commercialization activities; the commercialization and adoption of the Company's existing products and the success of any product the Company may offer in the future; the potential attributes and benefits of the Company's commercialized Platinum® protein sequencing instrument and kits and the Company's other products once commercialized; the Company's ability to obtain and maintain regulatory approval for its products, and any related restrictions and limitations of any approved product; the Company's ability to identify, in-license or acquire additional technology; the Company's ability to maintain its existing lease, license, manufacture and supply agreements; the Company's ability to compete with other companies currently marketing or engaged in the development or commercialization of products and services that serve customers engaged in proteomic analysis, many of which have greater financial and marketing resources than the Company; the size and growth potential of the markets for the Company's products and services, and its ability to serve those markets once commercialized, either alone or in partnership with others; the Company's estimates regarding future expenses, future revenue, capital requirements and needs for additional financing; the Company's financial performance; and other risks and uncertainties described under "Risk Factors" in the Company's most recent Annual Report on Form 10-K and Quarterly Reports on Form 10-Q and in the Company's other filings with the SEC. The Company cautions that the foregoing list of factors is not exclusive. The Company cautions readers not to place undue reliance upon any forward-looking statements, which speak only as of the date made. The Company does not undertake or accept any obligation or undertaking to release publicly any updates or revisions to any forward-looking statements to reflect any change in its expectations or any change in events, conditions, or circumstances on which any such statement is based.

Investor Day Agenda

Jeff Hawkins, CEO	Proteomics Market: Current & Future Perspective	10:00–10:20 AM
Todd Rearick, CTO	Technology Architecture for the Future	10:20–10:40 AM
Brian Reed, PhD	Innovating Discovery Applications in Proteomics	10:40–11:00 AM
John Vieceli, CPO	Platform Roadmap	11:00–11:20 AM
Jeff Hawkins, CEO	The Proteomics Lab of the Future	11:20–11:30 AM
Management	Q&A Session	11:30 AM–Noon

Proteomics Market: Current & Future Perspective



Proteins are the Core of Biological Discoveries



**Disease
Biomarkers**



**Therapeutic
Development**



**Biotech
Innovation**

**Proteins are the vital engines of biological systems,
playing crucial roles in both health and disease**

Proteome Complexity

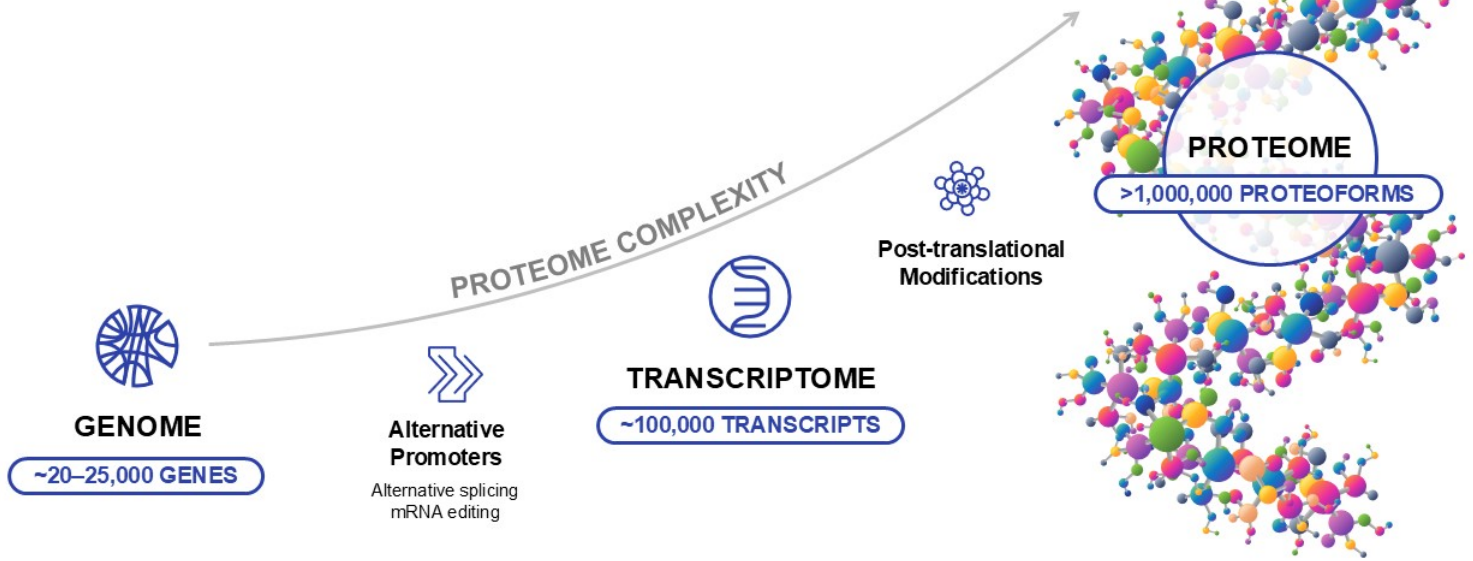

Transcriptomics Does Not Accurately Predict Protein Profiles

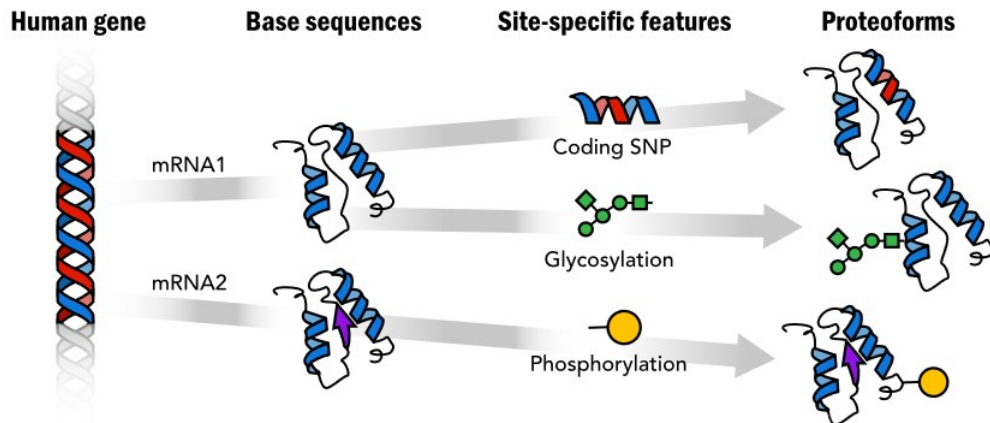

Disease Progression Goes Beyond the Protein Level

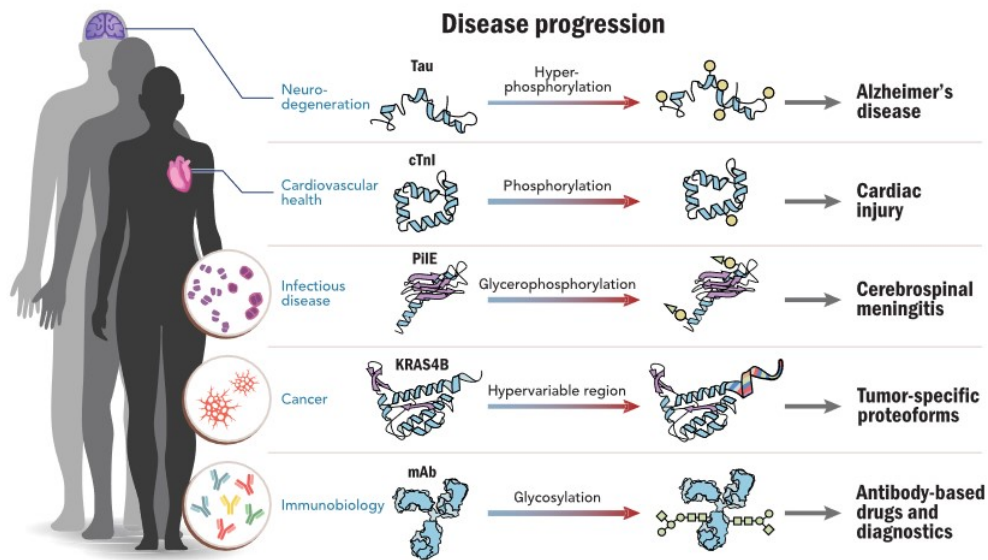

Proteomics is a Large and Growing Market Opportunity

\$75B+ Proteomics Market¹

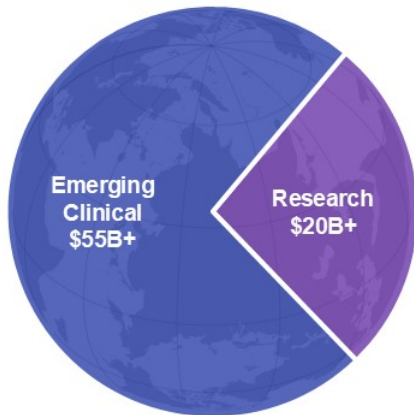

\$8B+ Initial Target Market²

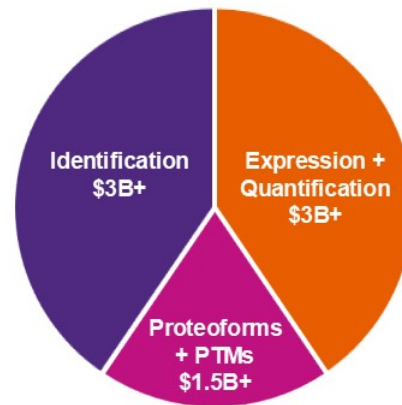

Platinum Use Cases Today

Identify Proteins Critical to Biology



In-gel digest of bio samples



Characterize antibodies



Identify co-IP proteins

Uncover + Understand Proteoforms



Post-translational modifications



Amino acid variants



RNA isoforms

Screen and Characterize Proteins with Barcodes



Protein/antibody engineering



mRNA vaccine development



Lipid nanoparticle delivery

How QSI Customers Are Leveraging Platinum



MRNA screening with protein barcodes for gene therapy



Studying citrullination PTMs



Characterizing far-flung extremophiles



Studying mRNA translation and PTMs



Studying disease isoforms



Mapping protein conformations using protein barcodes

The Proteomics Market is Poised for Significant Growth



Large-scale screening studies designed to identify clinically relevant biomarkers are increasing



Deep proteoform-level analysis will be needed to fully define and characterize the biomarkers with highest medical value



Population-scale studies will be needed to characterize what a “healthy” profile looks like

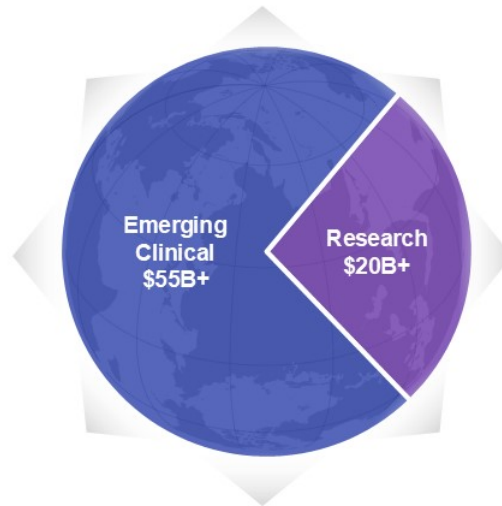

Routine use of multiomics requires creating new data analysis tools — these tools will require large amounts of training data



AI-driven drug development will drive the need for deeper proteomic data (amino acid level) to better inform and train the models



The proteome is dynamic — longitudinal data will be needed (i.e., repeat testing)

Technical Challenges in Proteomics Today

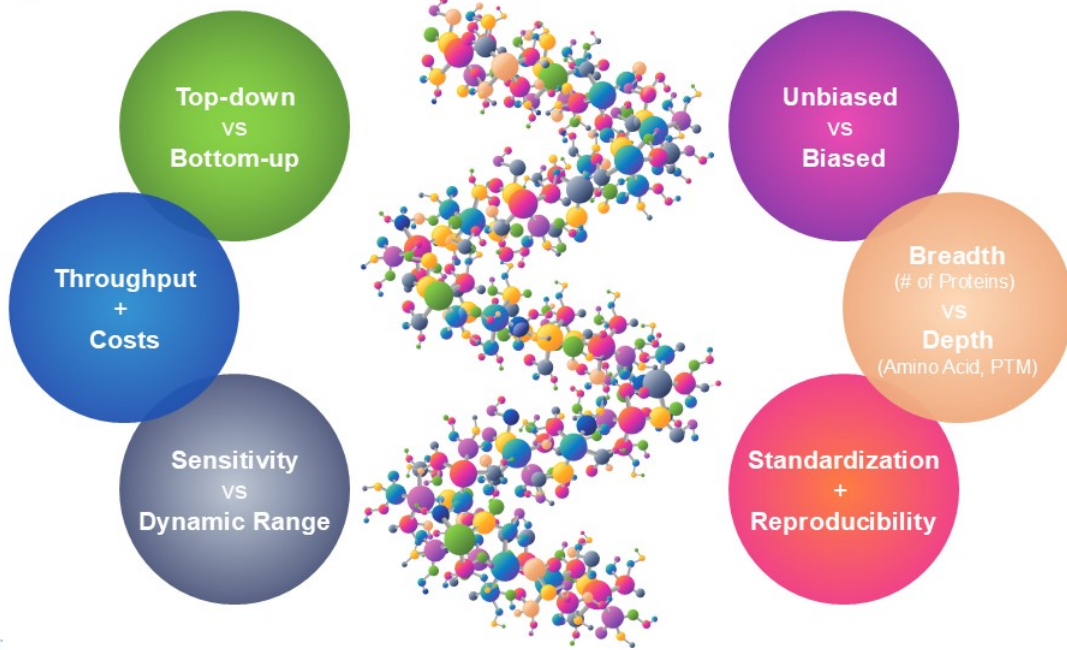

Multiple Specialized Platforms Required to Fully Interrogate the Proteome

Protein-level Screening

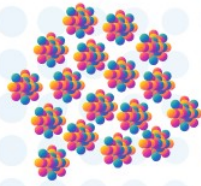

Samples: 100s–1,000s per study
Proteins: 100-1,000s per sample
Resolution: Protein

Mass
Spec

HT
Affinity
Assays

Ultra-
Sensitive
Protein
Detection

Western
Blots +
ELISA

Edman
Degradation

Focused + Deep Characterization



Samples: 10s–100s per study
Proteins: <50 per sample
Resolution: Amino acid; single-molecule



QSI is Best Positioned to Usher in a New Paradigm in Proteomics

Proteus™



Core technology is the only commercially available tech that can enable single-molecule, top-down, and bottom-up proteomics methods



New architecture (Proteus™), combined with other ongoing technology development initiatives, creates clear path to *de novo* sequencing



Ultrarapid sequencing chemistry can enable significant increase in sample throughput per day and unlock time-sensitive applications (e.g., clinical diagnostics) in the future

Platinum® Pro



Distribution Agreement in Place to Scale Adoption Across the US + Canada



Technology Development Pipeline

Quantum-Si Core Technologies

Platinum® System 2M Chip

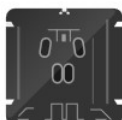

Chemistry Biomolecules

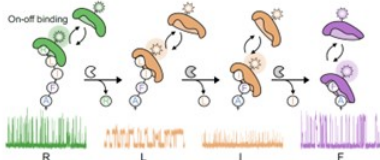
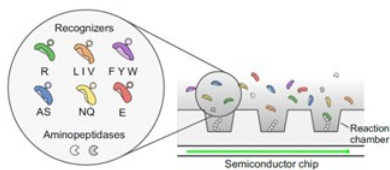

Algorithms Applications



Peptide Mapping



Barcode Applications



Variant Calling



PTM Characterization



Protein Identification

End-to-End Protein Analysis

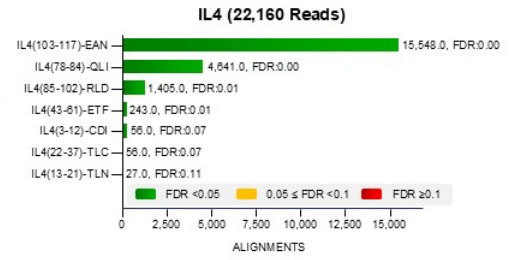

Prepare Proteins for Sequencing



Proteins are digested into short fragments (peptides)



Peptides are immobilized at the bottom of reaction chambers on our chip

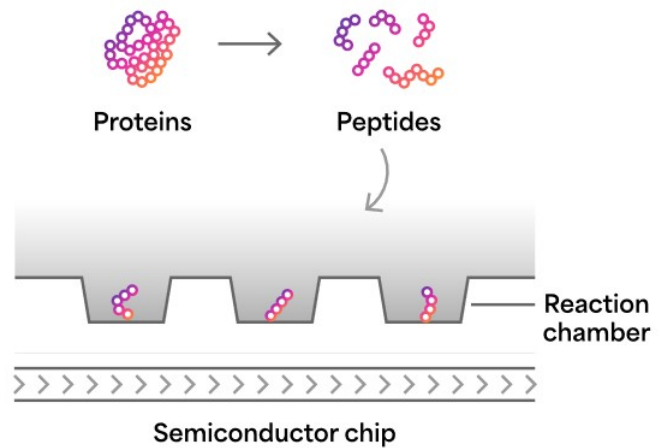

Kinetic Signatures Uniquely Identify Proteins + Proteoforms



Recognizers bind amino acids in sequence



FYW



LIV



R



AS



NQ



DE



Excitation



'R' Sequenced



'L' Sequenced



'I' Sequenced



'F' Sequenced



Recognition events produce kinetic signatures



Kinetic signature plot

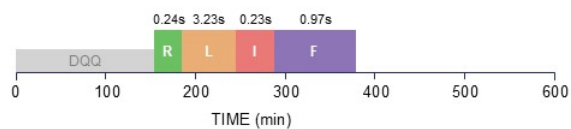

Rationale for New Technology Architecture



Semiconductors require large R&D investment



Re-partitioning of system allows for less expensive consumable



Leverage optical magnification to pack wells closer together and scale to billions of reads



Leverage high-performance, commercially-available imaging components

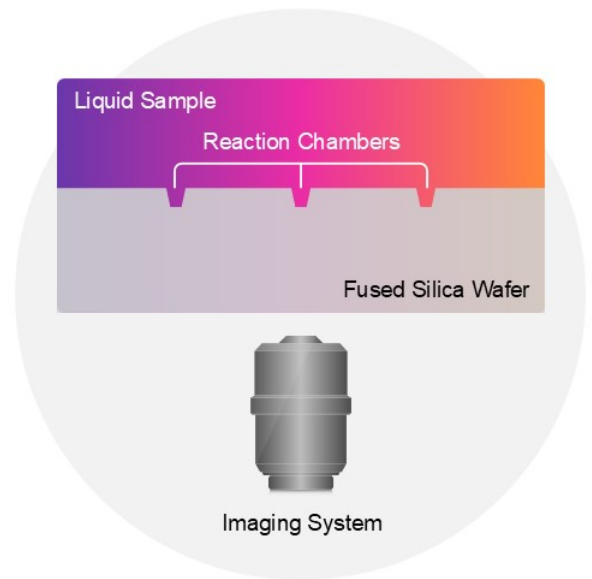

QSI Core Technologies



Chip



**Surface
Chemistry**



Instrument



**Library Prep +
Sequencing
Reagents**



Software

Chip + Surface Chemistry



Simple passive device with approximately 20M wells (per flow cell) at initial launch



Heavily de-risked — leverages existing design, materials, and fabrication methods



Compatible with existing surface chemistry

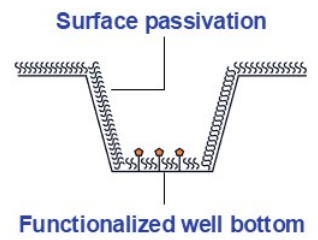
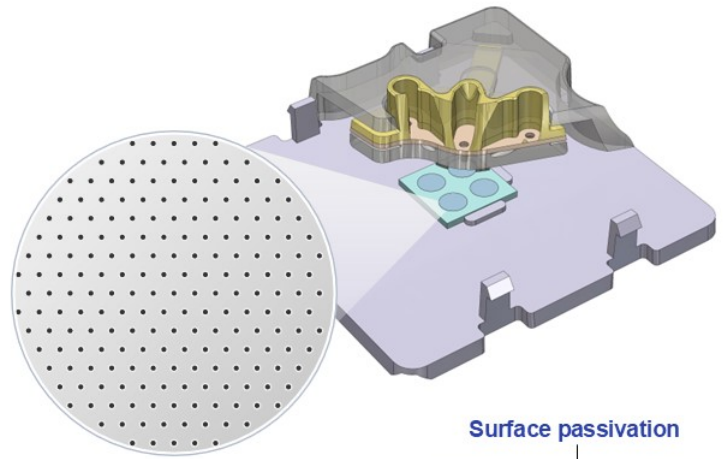

Proteus™ Consumable Development



Wafer process flow developed in production foundry



Prototype wafers fabricated and tested



Simple process has low-risk path to high-volume production

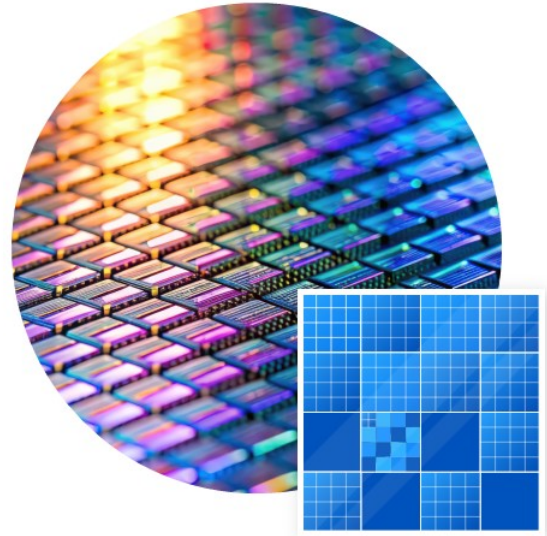

Wafer Fabrication Process Development



Foundry process modules work
and produce the desired well structure



Foundry partner for development
and production is in place

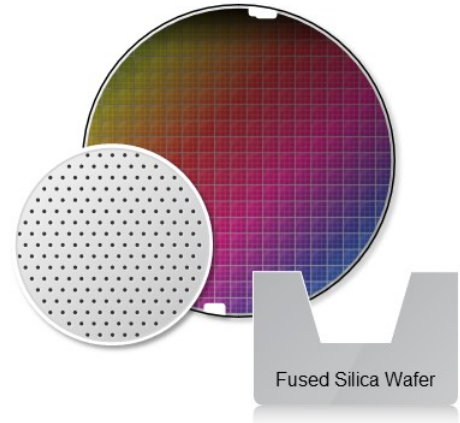

Proteus™ Instrument Development



Move imaging components to the system



Increase workflow automation



Leverage commercially available technologies for imaging and liquid handling



Takes advantage of significant investment in optics driven by NGS industry

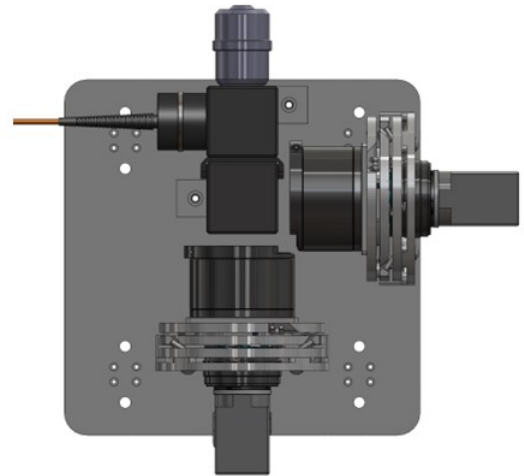

Library Prep + Sequencing Chemistry



Existing library prep and sequencing chemistry are completely portable



New system discriminates dyes with color rather than lifetime



Some new dye development is necessary, but is underway and low risk



Color Ratio is a Viable Alternative to Current Lifetime Detection



Key elements have already been de-risked



Move to color means we can leverage off-the-shelf camera technology

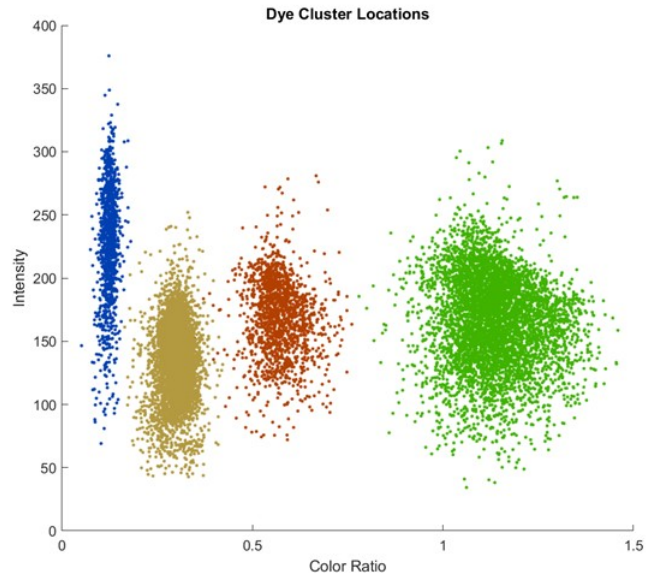

Analysis Software

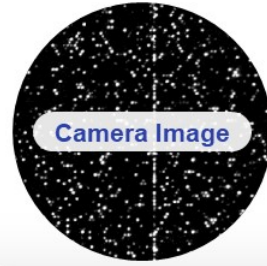

Registration Deconvolution



Backend processing is completely portable to new system

- Pulse detection, ROI calling, alignment, protein inference, and other applications



Development required for frontend image processing



Well within state-of-the-art capability

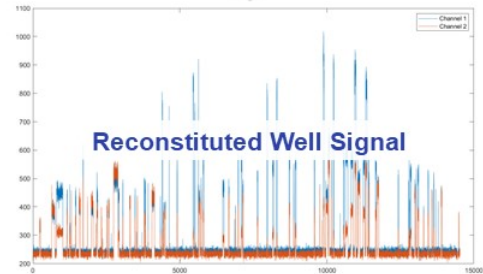

Instrument Roadmap



New architecture scales up to 10B reads per consumable



Enables shotgun proteomics of complex samples



Puts us on path to *de novo* sequencing

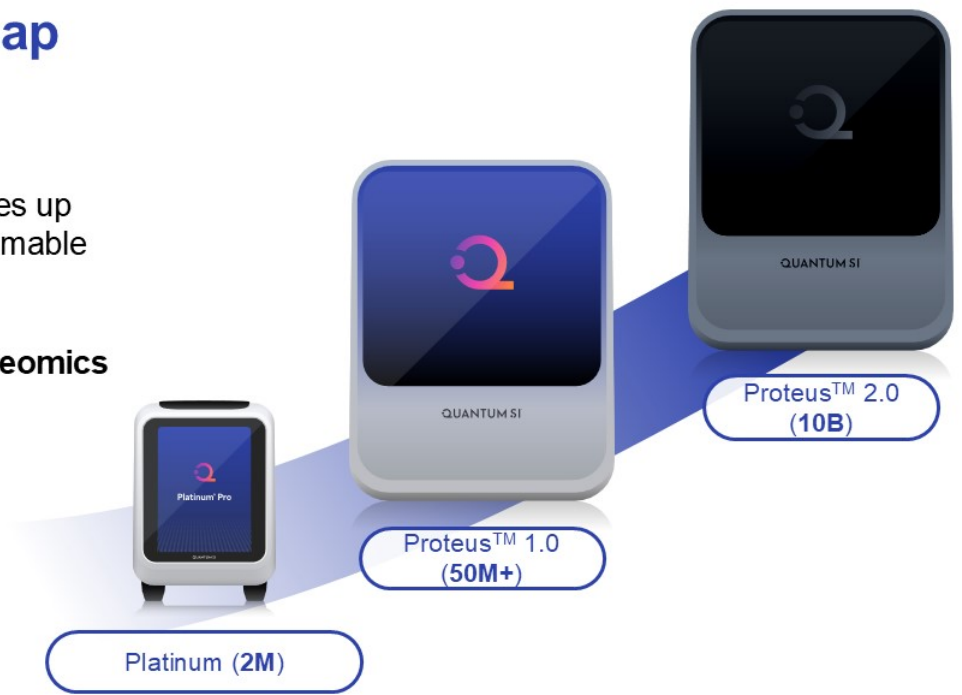

Innovation Toward the Most Advanced Set of Discovery Applications in Proteomics

Brian Reed



Agenda

Innovation at the Forefront of Proteomics

- 1 The path to complete proteome coverage
- 2 Ultrasensitive PTM detection for proteoforms
- 3 Deep, unbiased interrogation of high-complexity samples
- 4 Beyond sequencing: the first platform for top-down single-molecule proteomics

Acceleration on the Path to Complete Proteome Coverage

Sequence Proteins on Platinum

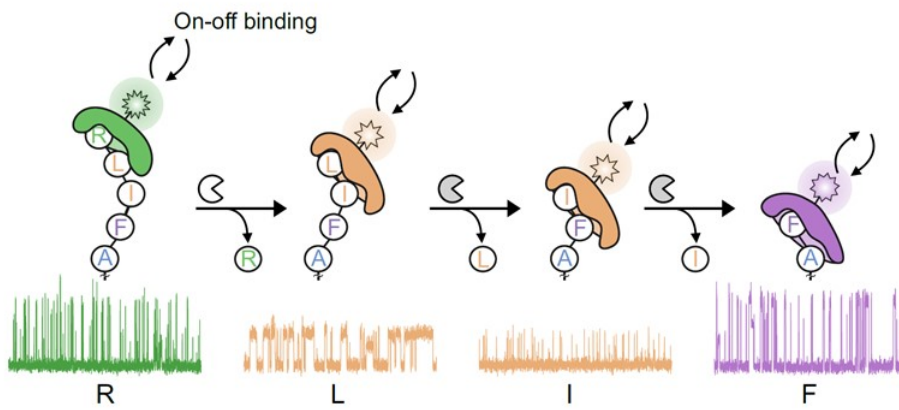

- **Each recognizer binds 1-3 cognate N-terminal amino acids (NAAs)**
- **Rapid on-off binding** generates a pulsing pattern detected by the chip
- **Extremely information-rich** data output: 10s-100s of pulsing events per amino acid

A Rapid Path to Complete Amino Acid Coverage

Our team has mastered the engineering and evolution of amino acid recognizers

Recognition Progress

Human proteome AA prevalence with recognizers

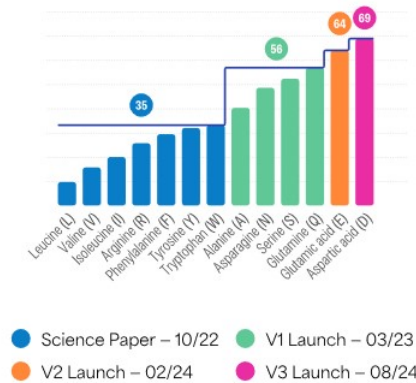

- **As a result of our rich kinetic output**, we have more data on our recognizers than possibly any other set of proteins in biotechnology
- Recognizers in the V3 kit recognize **13 of the 20 types of amino acids** (69%)
- **New recognizers** have already been developed and are on track for release in our next kit update
- We are on track to enable complete reference-free sequencing: **enables key applications like sequencing antibodies and cancer neoantigens *de novo***

Kinetic Signatures are Sensitive to Downstream Sequence

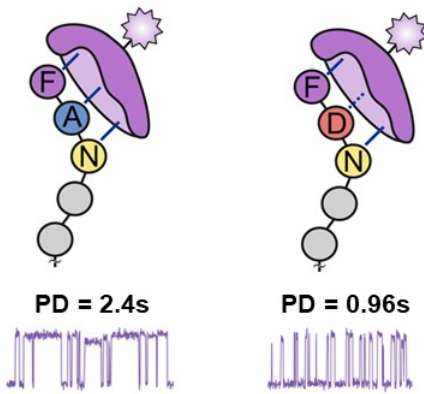

- **Recognizes physically contact residues** downstream of bound NAA
- **Influence is encoded in the peptide's kinetic signature** and is highly predictable
- **Kinetic signatures are a unique and powerful feature** of Quantum-Si's core technology
- **The acquisition of single-molecule kinetic information** gives us unprecedented insight into binding interactions

Ultrasensitive PTM Detection for Proteins and Proteoforms

Phosphorylation is the Most Abundant PTM in the Human Proteome

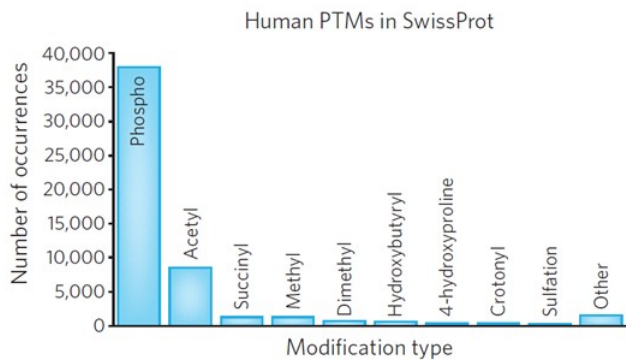

Nat Chem Biol 14, 206–214 (2018). <https://doi.org/10.1038/nchembio.2576>

- **Post-translational modifications (PTMs)** are central to protein function and implicated in human diseases
- **There are more than 400 different types of PTMs**; phosphorylation is the dominant type (~72% of all PTM sites)
- **Phosphorylation has the largest disease association**: 81% of all discovered PTM-associated diseases¹

Affinity Reagents as Ultrasensitive PTM Recognizers



- **Anti-PTM antibodies and other affinity reagents** work on chip for ultrasensitive PTM detection
- **Deliver the same real-time kinetic information** as NAA recognizers
- **Recognize PTMs anywhere** in the peptide (not just at the N-terminus)

Affinity Reagents as Ultrasensitive PTM Recognizers

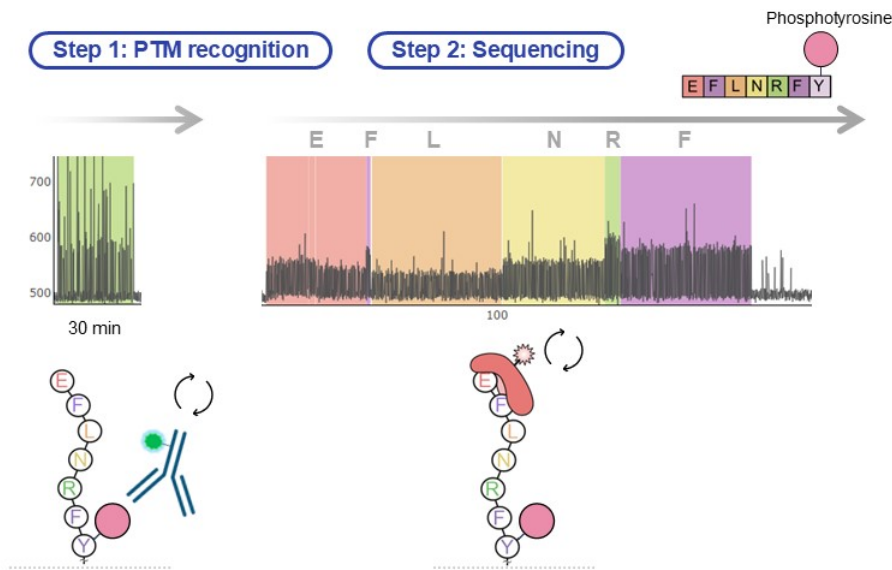

- **Step 1:** PTM detection for 30 minutes with PTM recognizer
- **Step 2:** Normal protein sequencing with NAA recognizers
- **PTM recognizers can be multiplexed and combined** with kinetic signatures to pinpoint PTMs in multisite configurations

Ultrasensitive Phosphotyrosine Detection with CDNF

CDNF_HUMAN

..QEAGGRPGADCEVCK[EFLNRFYK]SLIDRGVNFSLDTIEK ELISFCLDTK..

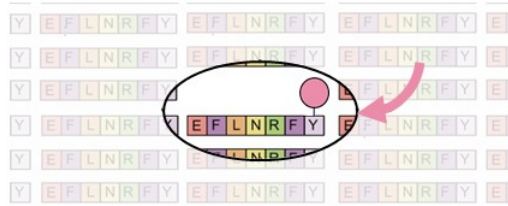
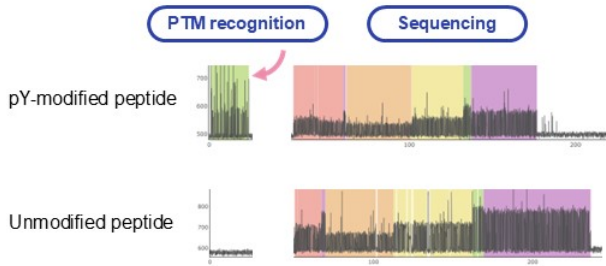

Detection of less than 1 PTM-modified peptide in 1,000

- **Extreme sensitivity to PTM stoichiometry** due to the clear pulsing pattern from PTM recognition
- **Example:** a CDNF peptide is detected at a ratio of less than 1 phosphorylated peptide in 1,000
- **Method can be extended to other types of PTMs**, e.g., ubiquitination, glycosylation; works with commercially available affinity reagents

Recognition of Human TAU Proteoforms

TAU_HUMAN

..VAVVRTPPKSPSSAK **SRLQTAPVMPDLK** NVK SK IGSTENLK HQPGGGK VQIINK K..

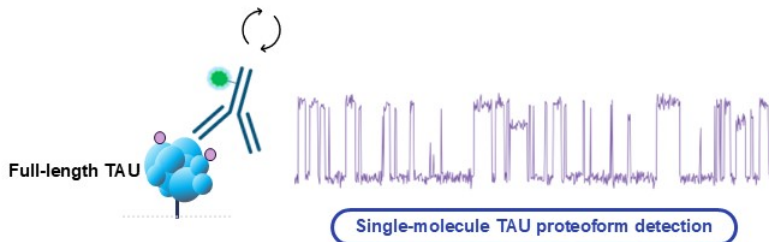
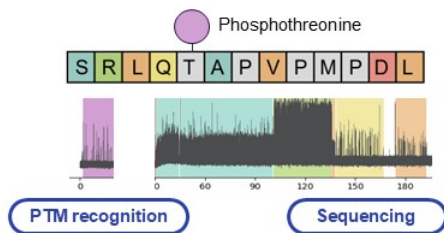

- **Affinity reagents** can be used in a bottom-up or top-down configuration
- **Example:** bottom-up recognition of pT* on human TAU peptides, top-down detection of immobilized full-length TAU proteoforms
- **Real-time approach enables proteoform detecting** reagents to be run simultaneously
- **First commercially available platform** for detection and differentiation of full-length proteoforms

Unbiased Interrogation of High-Complexity Samples with Quantum-Si's Core Technology

Sequencing Complex Biological Samples Unlocks Broad Access to Proteomics

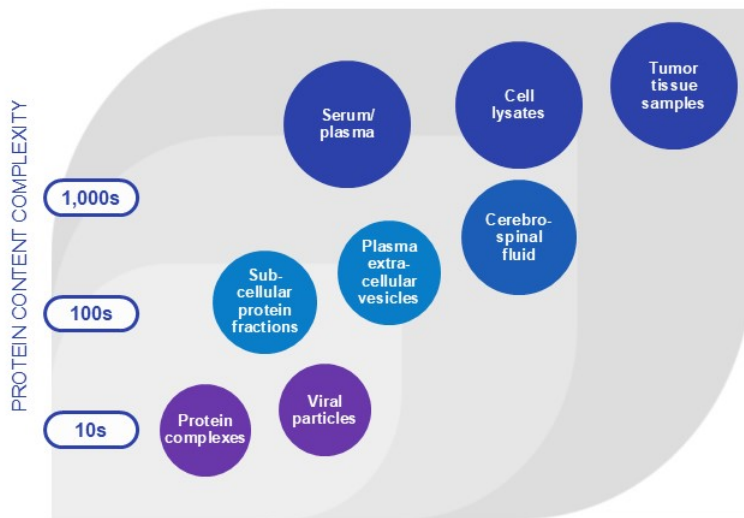

- **Biological samples like serum** contain hundreds to thousands of proteins with wide dynamic range of abundance
- **Unbiased, consistent, accessible interrogation** of these samples is a challenge in proteomics
- **Sequencing is not limited to predefined content:** enables discovery of changes in proteins and proteoforms that other methods are unable to access

Unbiased Interrogation of High-Complexity Samples



- **New chip architectures** and advances in sequencing chemistry will enable sequencing biological samples at ever-increasing depth
- **Future versions of the platform** will see shotgun sequencing with thousands of proteins identified
- **Barcoding approaches** and flowcell designs will enable sample multiplexing
- **Innovative methods to fractionate proteins** and to reduce sample complexity will be combined with these improvements

Fast Sequencing for Deep Coverage and Rapid Sample-to-Answer

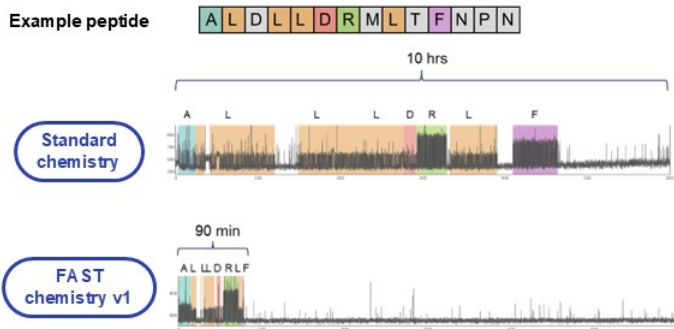

- **We have developed new sequencing chemistry** with a much faster rate of sequencing
- **With FAST chemistry**, we achieve equal performance to 10-hour runs in just 90 minutes (version 1)
- **Path to runs <30 minutes** for some applications with further development
- **Enables deep sample coverage** via iterative FAST sequencing and rapid sample-to-answer methods for clinical applications

**Beyond Sequencing: the First
Commercially Available Platform for
Top-Down Single-Molecule Proteomics**

Detecting Antibody Binding Events with the Power of Real-Time Kinetics

Dye-cycling enables ultrasensitive real-time detection of biomarkers

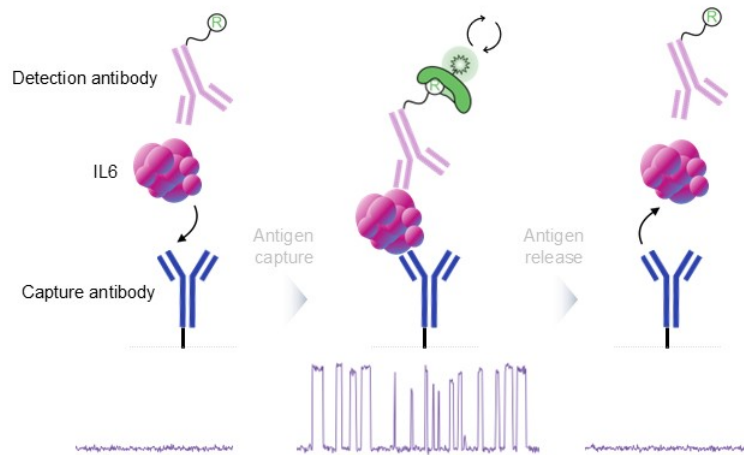

- **Detection of fixed protein panels** with high sensitivity is an increasingly important application in proteomics
- **We developed a single-molecule sandwich assay** that enables real-time detection of biomarkers
- **Dye-cycling approach uses our existing kits** to translate immune complex formation into a readily detected pulsing segment

Ultrasensitive Detection of Proteins in Serum

Direct detection of proteins in serum with high sensitivity

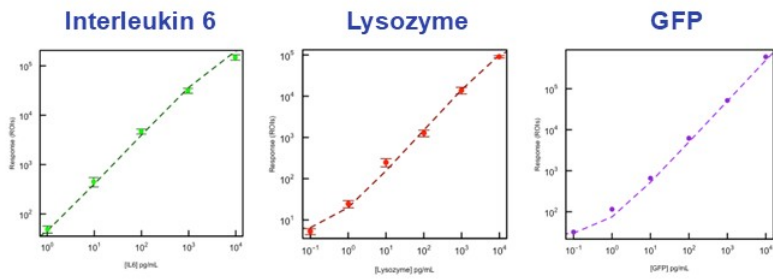

Spike-in titration experiments in serum demonstrate 0.1–1 pg/mL detection (path down to 10 fg/mL with further development)

Multiplexed Ultrasensitive Protein Biomarker Detection

Multiplexed detection of human IL6 and TNF- α

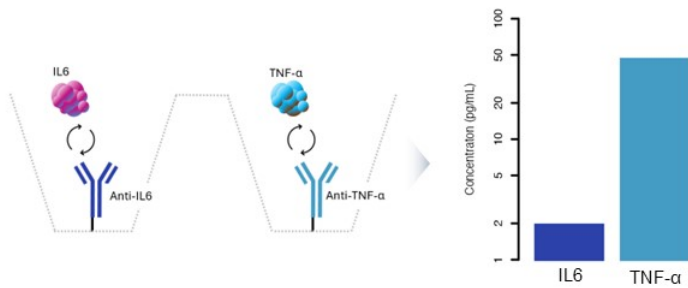

- **Affinity reagents against multiple biomarkers** can be loaded on the chip
- **Dye-cycling approach enables discrimination** of biomarkers by fluorescence and kinetic properties in multiplexed assays, along with PTMs

A Platform for Ultrasensitive Detection of Protein Panels

Multiplexed biomarker detection directly in serum



Protein panel size scales with the platform

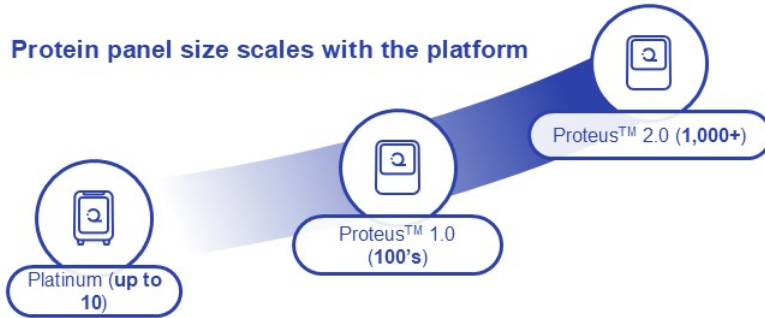

- **Sensitivity on Platinum** is suitable for commercialization of panels with up to 10 proteins
- **Panel size scales with the platform**, as well as capacity to multiplex samples
- **Proteins detected directly in serum** on chip, eliminating complex sample prep
- **Sample-to-answer in ~2 hours** with one instrument

Platform Roadmap

Nov 20, 2024

John Vieceli



Innovation Pipeline is Robust and Accelerating



Sequencing Analysis Software

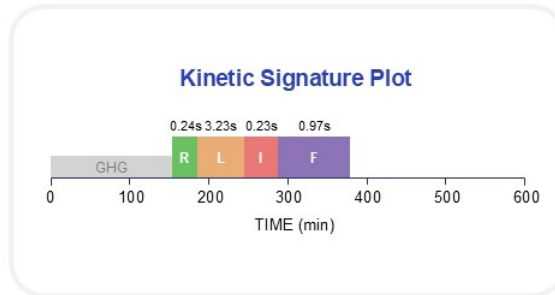
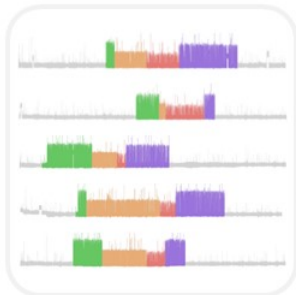
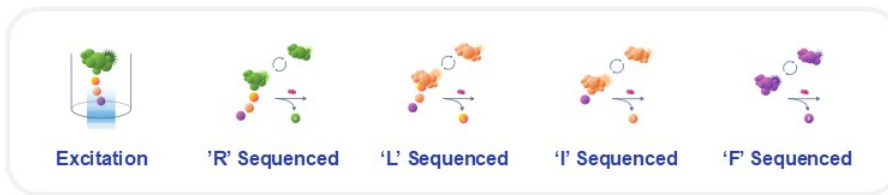

Sequence

Measure fluorescence from single molecule binding of N-terminal amino acid recognizers



Pulse Caller

Assign pulses to a recognizer based on fluorescence intensity and lifetime



Analyze

Determine amino acid sequence using kinetic signature

Software Workflows for Next-Gen Protein Sequencing™



Protein Inference

Kinetic signature enables inference of sample protein from whole human proteome panel

Rank	Inferred Protein	Score	Likelihood	Mass (kDa)	Length
1	IL4 spIP04112IL4_HUMAN	11.035496	99.99%	17	153
2	spIP06127ICD5_HUMAN	0.593929	44.78%	55	495
3	spIQ15208ISTK38_HUMAN	0.582068	44.12%	54	465
4	spIQ96LQ0IPPR36_HUMAN	0.506878	39.76%	49	422
5	spIQ81WR1ITRI59_HUMAN	0.440162	35.6%	47	403
6	spIQ9UMR3ITBX20_HUMAN	0.428596	34.85%	49	447
7	spIQ96EU6IRRP36_HUMAN	0.403635	33.21%	30	259
8	spIQ9H2F9ICCD68_HUMAN	0.371386	31.02%	39	335
9	spIQ8IVI9INOSTN_HUMAN	0.365859	30.63%	58	506
10	spIO9BZ81IMAGB5_HUMAN	0.310895	26.72%	32	275



ProteoVue™ Variant Calling

Kinetic signature enables differentiation of protein variations at the single amino acid level

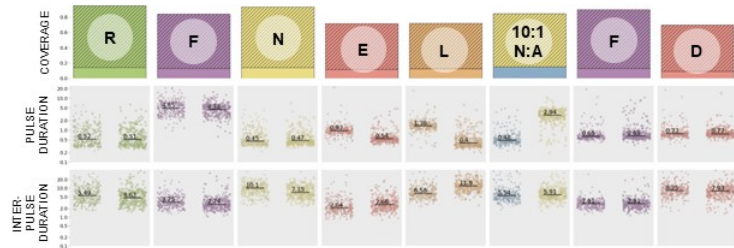

QUANTUM SI

Artificial Intelligence

N-terminal Amino Acid Recognizer Development

 **FYW**  **LIV**  **R**

Science Publication
Oct 2022

 **AS**  **NQ**

Version 1 Kit
Mar 2023

 **DE**

Version 2/3 Kit
Jan/July 2024

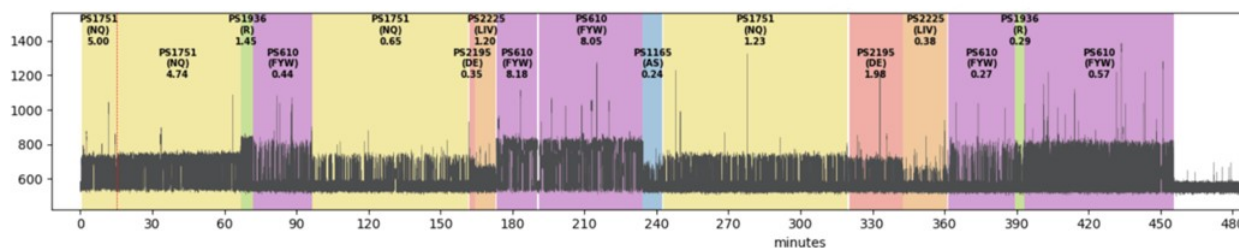

Recognizer Protein Design AI

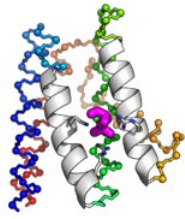

Amino acid recognizer
backbone design



Amino acid recognizer
sequence design



Orthogonal verification
of amino acid recognizer
protein design



NVIDIA

Protein design AI leverages **NVIDIA GPUs on-premises and in Amazon Cloud**

Pulse Width Prediction Using Artificial Intelligence



Platinum Sequencing

QSI is continually increasing the size of the training data with more proteins and/or new binders



Pulse Width Prediction AI

Currently predicts ~4.6 million pulse widths used in analysis



Better Performance

Pulse width prediction AI trained with more platinum sequencing data improves protein detection performance

QUANTUM SI

Platinum[®] Pro

Platinum[®] Instrument



Customers identified opportunities to improve workflow and UI/UX



Functionality limited to protein & peptide sequencing



Local analysis enabled by additional server

Introducing Platinum[®] Pro



Streamlined workflow
and reduced hands-on time



Pro Mode enables new
applications



Onboard analysis or via the cloud



Enhanced user interface

Streamlined Workflow Improves Usability

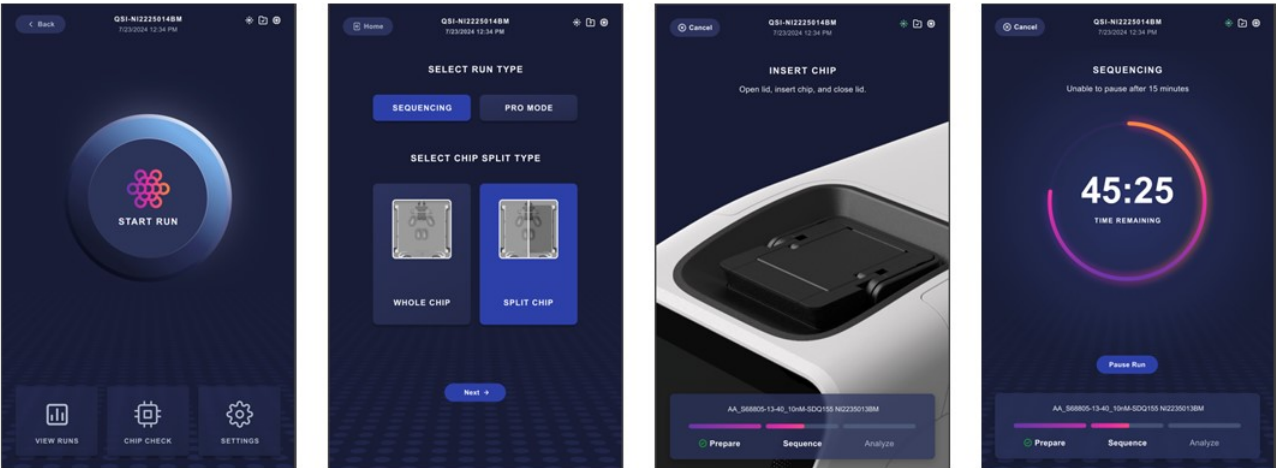

Pro Mode Available only on Platinum Pro

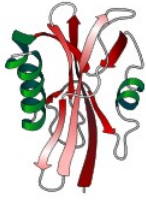

Protein of Interest



Dye-labeling Kit

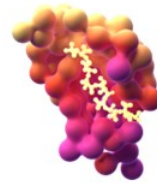

Protein Binding

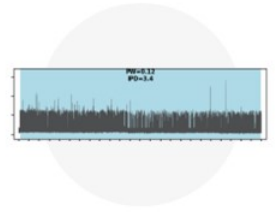

Binding Kinetics



Kit and platform enable detection of **single-molecule protein binding and kinetics**

Peptide Barcodes can be Used to Monitor Protein Expression Both *In Vivo* or *In Vitro*

IN VIVO



Equimolar 5 barcode mix encoded as mRNA and packaged into LNPs



Inject into mouse model; harvest target tissues



Enrich for target protein, functionalize, cleave, and sequence barcodes



IN VITRO

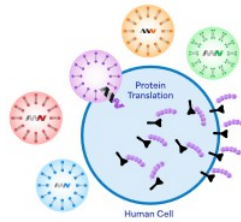

QUANTUM SI

V2 Library Preparation Kit Improvements



Simplified workflow reduces need for buffer exchange



Improved performance with ~80% of proteins successfully inferred



Reduced protein input five-fold

QUANTUM SI

Proteus™

Proteus™ Increases Throughput + Automation



Switch from semiconductor to optical architecture with patterned array for throughput scalability



Liquid handling automation simplifies workflow and reduces hands-on time



Up to an order of magnitude throughput increase per sample relative to Platinum at initial launch

Proteus™ Increases Number of Samples



Run one or two samples simultaneously



Reagent cartridges with sequencing workflow automation



Run up to 8 samples in one sequencing run



The Proteomics Lab of the Future



QSI's Pipeline is Heavily De-risked Compared to Other Proteomics Companies



Builds upon QSI's existing commercially available technologies



Industry-leading protein and enzyme engineering program operating at scale and with high success rates



Manufacturing infrastructure in place and routinely producing and delivering product to customers today



Strategic Partnerships to Accelerate Commercial Adoption and Deliver on Innovation Roadmap



QSI is Best Positioned to Usher in a New Paradigm in Proteomics



New platform architecture designed so QSI will not be feature limited (can scale to billions of reads)



QSI core technology is the only commercially available tech that can enable single-molecule, top-down, and bottom-up proteomic analysis



QSI ultrarapid sequencing can enable significant increase in sample throughput per day and unlock time-sensitive applications (e.g. clinical diagnostics) in the future



QSI new architecture, combined with other ongoing technology development initiatives, creates clear path to *de novo* sequencing

QSI Near-term Pipeline Will Unlock Opportunities Across All Market Segments

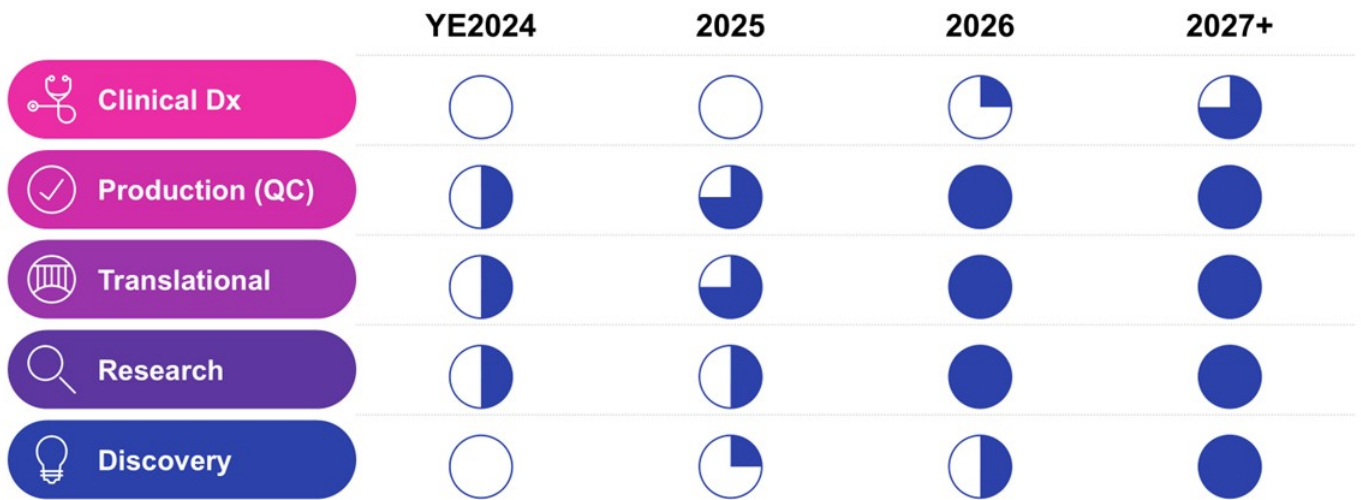

Proteomics Lab Today



Many specialized platforms needed to fully interrogate the proteome



Technical tradeoffs when selecting between the breadth of protein coverage and depth of insights



High capital costs and manual workflows limit the number of laboratories capable of performing proteomics



QSI Will Power the Proteomics Lab of the Future



One platform and core technology capable of addressing the broadest range of proteomics analysis methods



Eliminate technical tradeoffs – single-molecule, amino acids and PTMs, top-down or bottom-up, ultrasensitive, scalable throughput



Affordable and automated, allowing any lab — anywhere — to be a proteomics core lab



Q&A

